

AAPM/RSNA Physics Tutorial for Residents

Fundamental Physics of MR Imaging¹

Robert A. Pooley, PhD

Learning the basic concepts required to understand magnetic resonance (MR) imaging is a straightforward process. Although the individual concepts are simple, there are many concepts to learn and retain simultaneously; this situation may give the illusion that learning the physics of MR imaging is complicated. It is important for the radiologist who interprets MR images to understand the methods used to create the images because image contrast specifically depends on how the image data were acquired. Initial concepts include formation of magnetic fields from electric currents in loops of wire, the resonance phenomenon, the hydrogen proton and its frequency of precession, and absorption of radiofrequency energy. These concepts can then be applied to learn about T1 and T2 relaxation and contrast and how the acquisition parameters of echo time and repetition time can be used to achieve these image contrasts. Basic pulse sequences include the spin-echo, multiecho spin-echo, turbo spin-echo, inversion-recovery, and gradient-recalled-echo sequences.

©RSNA, 2005

Abbreviations: ADC = analog-to-digital converter, CSF = cerebrospinal fluid, RF = radiofrequency, TE = echo time, TR = repetition time

RadioGraphics 2005; 25:1087–1099 • Published online 10.1148/rg.254055027 • Content Codes: **MR** **PH**

¹From the Department of Radiology, Mayo Clinic, 4500 San Pablo Rd, Jacksonville, FL 32224. From the AAPM/RSNA Physics Tutorial at the 2004 RSNA Annual Meeting. Received February 11, 2005; revision requested March 22 and received April 22; accepted April 25. The author has no financial relationships to disclose. **Address correspondence to** the author (e-mail: pooley.robert@mayo.edu).

©RSNA, 2005

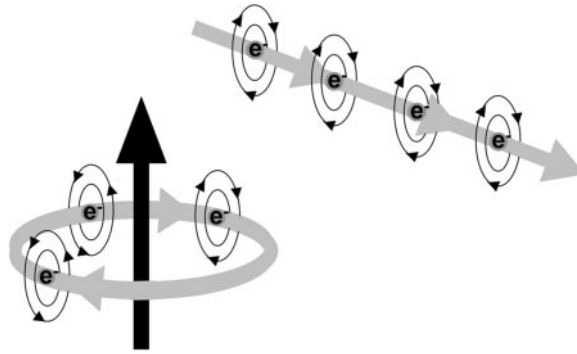

Figure 1. Electrons flowing along a wire. An electric current in a loop of wire will produce a magnetic field (black arrow) perpendicular to the loop of wire. e^- = electron.

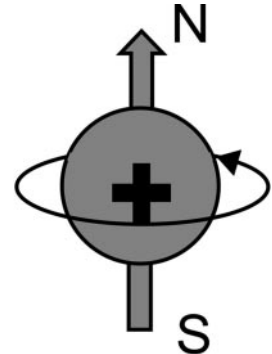

Figure 2. Hydrogen proton. The positively charged hydrogen proton (+) spins about its axis and acts like a tiny magnet. N = north, S = south.

Introduction

For radiologists who interpret magnetic resonance (MR) images, it is extremely important to understand the mechanisms that are used to create the image data. This is especially important in MR imaging, where image contrast can change in a subtle or drastic way depending on how the data are acquired.

This article will provide an introduction to the physics of MR imaging. Some very basic initial concepts will be described, and these will be combined to form the foundation for the more complicated concepts of T1 and T2 relaxation and contrast. Finally, several basic pulse sequences will be discussed.

An attempt has been made to keep the descriptions quite simple; they assume no prior understanding of MR physics, and no complicated math is included. A difficulty remains in the fact that all of the simple concepts must be retained simultaneously in order to apply these concepts to more complicated learning situations.

Initial Concepts

Production of a Magnetic Field

When an electron travels along a wire, a magnetic field is produced around the electron (Fig 1).

When an electric current flows in a wire that is

formed into a loop, a large magnetic field will be formed perpendicular to the loop.

Resonance

Resonance aids an efficient transfer of energy. This is true, for example, when pushing a child on a swing. The child will swing back and forth at a particular frequency. If we push the swing at the right time, we will efficiently transfer energy to the swing and child. If we consistently push at the right time, we will be in resonance with the swing, and the efficient transfer of energy will allow the child to swing higher.

Hydrogen Protons

It is necessary to have a source of hydrogen protons (protons in the nuclei of hydrogen atoms, which are associated with fat and water molecules) in order to form our MR signal. The hydrogen proton is positively charged and spins about its axis (like a child's spinning top). This positively charged spinning proton acts like a tiny magnet (Fig 2). The hydrogen protons in our body thus act like many tiny magnets.

Main Magnetic Field

The main magnetic field of an MR system comes from a large electric current flowing through wires that are formed into a loop in the magnet of the

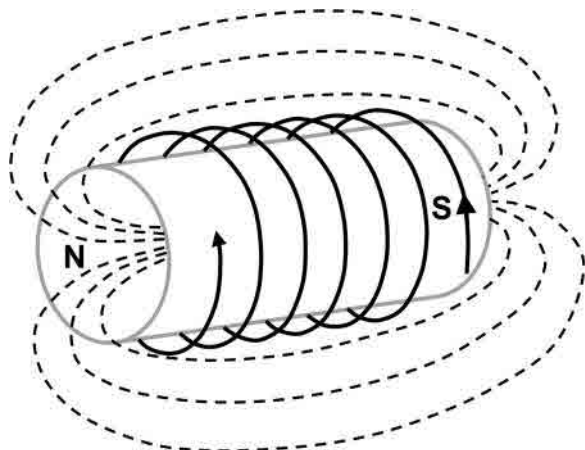

Figure 3. Main magnetic field. A large electric current in loops of wire at superconducting temperatures will produce a very large magnetic field. *N* = north, *S* = south.

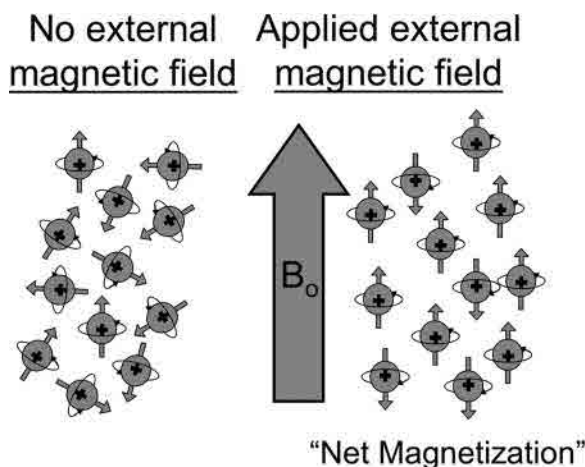

Figure 4. Alignment of protons with the B_0 field. With no external magnetic field, hydrogen protons (+) are oriented randomly. When the protons are placed in a strong magnetic field (B_0), a net magnetization will be produced parallel to the main magnetic field.

imaging system (Fig 3). A typical clinical MR system will have a magnetic field strength of 1.5 T (tesla) (1 T = 10,000 gauss). The wires are immersed in liquid helium (at superconducting temperatures) so that very large currents can be used to produce the strong magnetic field. The magnet can be “ramped” with a power supply (to inject electric current into the coils of wire), and the power supply can then be removed. The imaging system can retain this electric current for many years (with no need to inject additional electric

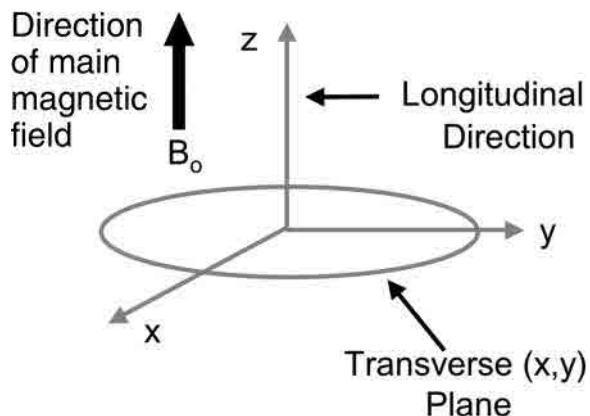

Figure 5. Coordinate system. For a typical 1.5-T cylindrical-bore imaging unit, the *z* axis (longitudinal direction) is often aligned with the main magnetic field; the plane perpendicular to this is called the transverse plane.

current) with only minimal loss in electric current and minimal decrease in magnetic field strength. The liquid helium levels in the magnet will need to be filled at regular intervals (once per month to once every few years, depending on the magnet design).

Putting these basic elements together, there are protons in the body, positively charged and spinning about their axes, that act like tiny magnets. They are randomly oriented so that their magnetic fields do not sum but rather cancel out (Fig 4). When we place these protons in a strong magnetic field (called B_0), some will tend to align in the direction of the magnetic field and some will tend to align in a direction opposite to the magnetic field. The magnetic fields from many protons will cancel out, but a slight excess of the protons will be aligned with the main magnetic field, producing a “net magnetization” that is aligned parallel to the main magnetic field. This net magnetization becomes the source of our MR signal and is used to produce MR images.

Coordinate System

Because we have just introduced a reference to a direction, it is important to discuss the coordinate system, which will orient us for future discussion. The direction parallel to the main magnetic field is the longitudinal direction, which may also be called the *z* direction (Fig 5). For typical 1.5-T

superconducting cylindrical-bore magnets, the z direction is horizontal and corresponds to the head-to-foot (or foot-to-head) direction. The plane perpendicular to this direction is called the transverse plane or the x-y plane. For a patient who is headfirst and supine in a superconducting magnet, the x direction is often chosen to be the left-right direction of the patient and the y direction is often chosen to be the anterior-posterior direction. Interestingly, the transverse plane matches the axial plane for typical 1.5-T magnets.

Precession

A spinning top spins about its axis. The force of gravity attempts to pull the top so that it will fall down. The combined effects of gravity and the spinning motion cause the top to precess. The same thing happens with nuclear precession.

There are protons that are spinning and acting like tiny magnets. If we place these spinning protons in a strong magnetic field, the force from the magnetic field interacts with the spinning protons and results in precession of the protons (Fig 6).

It is the frequency of precession that is important. How many revolutions in a second does the proton precess? We must know this precessional frequency just as we must know the frequency of the pendulum motion of a child's swing. It is this proton precessional frequency that allows us to create a situation through which the resonance phenomenon can be used to efficiently transfer energy to the protons.

The proton precessional frequency is determined from the Larmor equation, in which the frequency of precession, f , is equal to a constant times the main magnetic field strength (Fig 7). The constant is called the gyromagnetic ratio and is a characteristic of each type of nuclei. For hydrogen protons, the gyromagnetic ratio is equal to 42.6 MHz/T (megahertz per tesla). The main magnetic field strength, B_0 , depends on the magnet design. For a typical superconducting MR system, the magnetic field strength may be 1.5 T. The frequency of precession then will equal 42.6 MHz/T \times 1.5 T or about 64 MHz (64 million times per second).

Radiofrequency Energy

Radiofrequency (RF) energy comes in the form of rapidly changing magnetic and electric fields generated by electrons traveling through loops of wire with the direction of current flow rapidly chang-

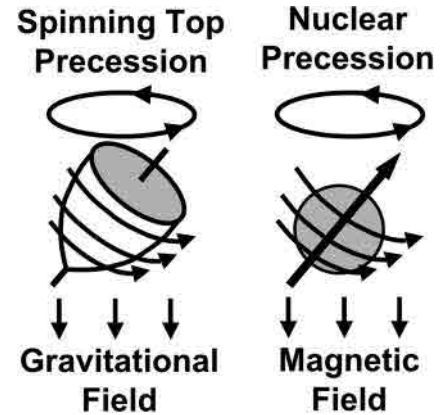

Figure 6. Precession. Precession of a spinning top and nuclear precession are similar in that an external force combined with the spinning motion causes precession.

$$f = \gamma B_0$$

Frequency of precession

f

γ Gyromagnetic ratio

B_0 Main magnetic field strength

Figure 7. Larmor equation. The Larmor equation allows us to determine the frequency of precession of a proton in a magnetic field.

ing back and forth at “radio frequencies.” The magnetic field (generated by the flow of electrons) will also rapidly change directions. Radio and television stations broadcast at frequencies in units of megahertz, so a broadcast at 89.9 on your FM dial is really at 89.9 MHz. This RF energy is not far from the precessional frequencies of a 1.5-T magnet (64 MHz) and is a reason why MR systems must be shielded from external RF signals.

For the MR system, this RF energy is transmitted by an RF transmit coil (eg, body coil, head coil, knee coil). Typically, the RF is transmitted for a short period of time; this is called an RF pulse. This transmitted RF pulse must be at the precessional frequency of the protons (calculated via the Larmor equation) in order for resonance to occur and for efficient transfer of energy from the RF coil to the protons.

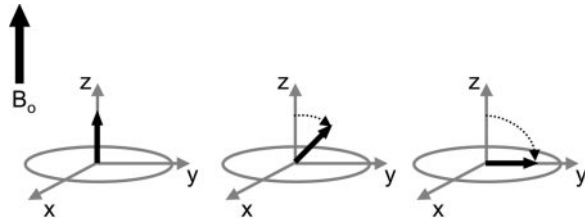

Figure 8. Absorption of RF energy. Left: Prior to an RF pulse, the net magnetization (small black arrow) is aligned parallel to the main magnetic field and the z axis. Center and right: An RF pulse at the Larmor frequency will allow energy to be absorbed by the protons, thus causing the net magnetization to rotate away from the z axis.

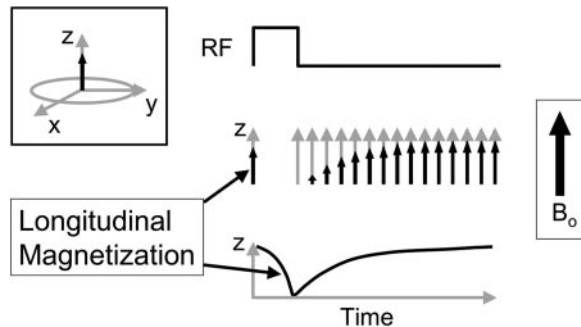

Figure 9. Longitudinal (T1) relaxation. Application of a 90° RF pulse causes longitudinal magnetization to become zero. Over time, the longitudinal magnetization will grow back in a direction parallel to the main magnetic field.

Absorption of RF Energy

Recall that when protons in our body are placed in the vicinity of a strong magnetic field, the magnetic fields from these protons combine to form a net magnetization. This net magnetization points in a direction parallel to the main magnetic field (also called the longitudinal direction). As energy is absorbed from the RF pulse, the net magnetization rotates away from the longitudinal direction (Fig 8). The amount of rotation (termed the flip angle) depends on the strength and duration of the RF pulse.

If the RF pulse rotates the net magnetization into the transverse plane, that is termed a 90° RF pulse. If the RF pulse rotates the net magnetization 180° into the -z direction, that is termed a 180° RF pulse. The strength and/or duration of the RF pulse can be controlled to rotate the net magnetization to any angle. We will see that 90° and 180° RF pulses are important when discussing the spin echo (SE) and that smaller flip angles

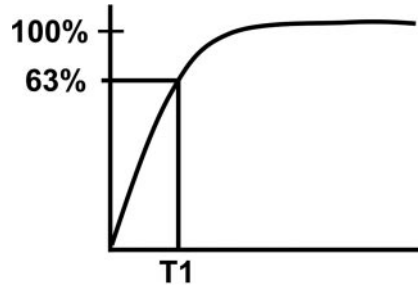

Figure 10. Definition of T1. T1 is a characteristic of tissue and is defined as the time that it takes the longitudinal magnetization to grow back to 63% of its final value.

are important when discussing fast imaging techniques as in gradient-recalled-echo (GRE) imaging.

T1 Relaxation and Contrast

We may now apply the fundamental concepts presented earlier to more complicated MR situations. Net magnetization that is aligned with the longitudinal direction may be called longitudinal magnetization. After a 90° RF pulse rotates the longitudinal magnetization into the transverse plane, this magnetization may be called transverse magnetization. After a 90° RF pulse, the longitudinal magnetization is zero. The magnetization then begins to grow back in the longitudinal direction (Fig 9). This is called longitudinal relaxation or T1 relaxation. The rate at which this longitudinal magnetization grows back is different for protons associated with different tissues and is the fundamental source of contrast in T1-weighted images. T1 is a parameter that is characteristic of specific tissue (and also depends on the main magnetic field strength) and is related to the rate of regrowth of longitudinal magnetization.

The net magnetization does not rotate back up but rather increases in a direction always parallel to the longitudinal direction, which is the direction of the main magnetic field. We can plot an example of this effect (Fig 9). The definition of T1 is the time that it takes for the longitudinal magnetization to reach 63% of its final value, assuming a 90° RF pulse (Fig 10). The magnetization of tissues with different values of T1 will grow back in the longitudinal direction at different rates.

Figure 11. T1-weighted contrast. Different tissues have different rates of T1 relaxation. If an image is obtained at a time when the relaxation curves are widely separated, T1-weighted contrast will be maximized. *Mag* = magnetization.

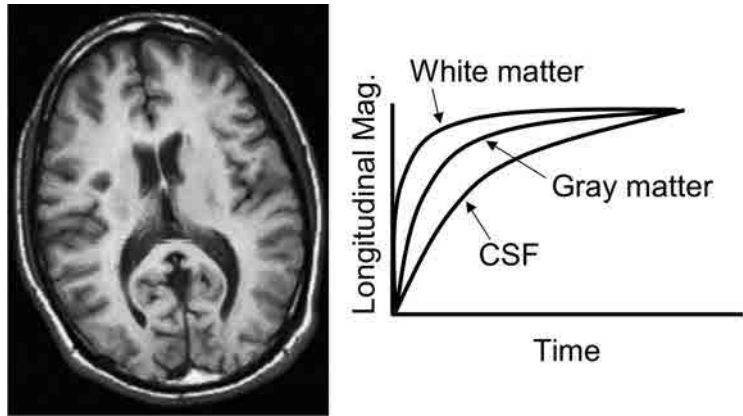

White matter has a very short T1 time and relaxes rapidly. Cerebrospinal fluid (CSF) has a long T1 and relaxes slowly. Gray matter has an intermediate T1 and relaxes at an intermediate rate (Fig 11). If we were to create an image at a time when these curves were widely separated, we would produce an image that has high contrast between these tissues. Thus, white matter contributes to the lighter pixels, CSF contributes to the darker pixels, and gray matter contributes to pixels with intermediate shades of gray. This type of contrast mechanism is termed T1-weighted contrast. If we were to create an image at a time when the curves were not widely separated, the image would not have much T1-weighted contrast.

T2 Relaxation and Contrast

The description of T2 (or transverse) relaxation begins with the net magnetization aligned with the z direction and a 90° RF pulse that rotates this net magnetization into the transverse plane (Fig 12). Recall that the net magnetization is made up of contributions from many protons, which are all precessing. During the RF pulse, the protons begin to precess together (they become “in phase”). Immediately after the 90° RF pulse, the protons are still in phase but begin to dephase due to several effects. These effects are listed in the Table.

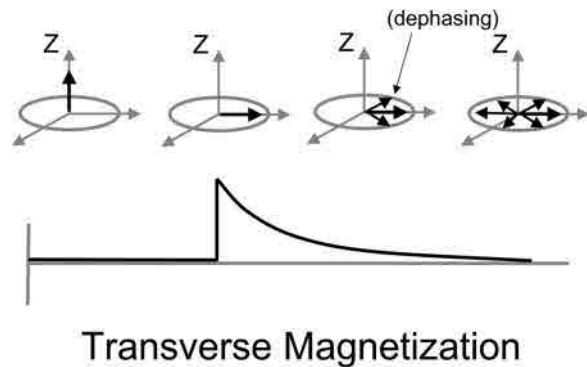

Figure 12. Transverse (T2*) relaxation. Immediately after application of a 90° RF pulse, transverse magnetization is maximized; it then begins to dephase due to several processes (Table). The signals from these dephasing protons begin to cancel out, and the MR signal decreases.

Effects That Cause T2* and T2 Dephasing

Causes of T2* Dephasing	Causes of T2 Dephasing
Spin-spin interactions	Spin-spin interactions
Magnetic field inhomogeneities	
Magnetic susceptibility	
Chemical shift effects	

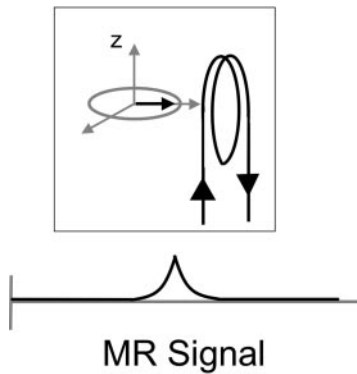

Figure 13. Measurement of the MR signal. A magnetic field (black arrow) that is near and perpendicular to a loop of wire will produce an electric current in the loop. The current can be digitized and stored for later reconstruction into an MR image.

Dephasing due to one of these effects (magnetic field inhomogeneities) will be discussed. Recall that the Larmor equation allows us to determine the precessional frequency of a proton as the product of the gyromagnetic ratio and main magnetic field strength. The gyromagnetic ratio is a constant; however, owing to hardware limitations, the main magnetic field is not perfectly homogeneous across the imaging volume. Thus, protons that experience slightly different magnetic field strengths will precess at slightly different Larmor frequencies. Protons that were in phase immediately after the 90° RF pulse, because they are precessing at slightly different frequencies, will begin to dephase.

Dephasing normally occurs due to all four effects, and in this case, the dephasing may be called $T2^*$ ($T2$ star) decay or $T2^*$ relaxation. The dephasing due to three of the effects can be reversed through a special “trick” discussed later. In this case, when dephasing is due only to the effect called spin-spin interactions, the dephasing may be called $T2$ decay or $T2$ relaxation. $T2$ is a parameter that is characteristic of specific tissue

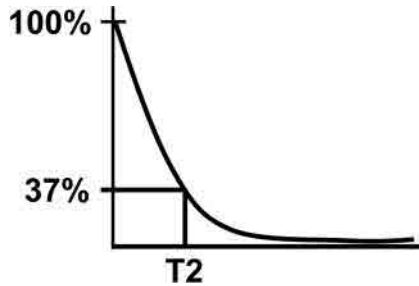

Figure 14. Definition of $T2$. $T2$ is a characteristic of tissue and is defined as the time that it takes the transverse magnetization to decrease to 37% of its starting value.

and characterizes the rate of dephasing for the protons associated with that tissue.

We can measure the amount of transverse magnetization with a receiver coil. Recall that an electric current in a wire will produce a magnetic field perpendicular to the loop of wire. Measurement of the transverse magnetization (which is our “MR signal”) occurs through an opposite effect. In this case, the transverse magnetization, which is a magnetic field, can induce a current in a loop of wire (Fig 13). This induced electric current is then digitized and recorded in the computer of the MR system for later reconstruction as an MR image.

When the transverse magnetization is completely in phase, our measured MR signal is at a maximum. When the transverse magnetization begins to dephase, our measured MR signal begins to decrease until the magnetization is completely dephased, at which time the measured MR signal is zero (Fig 12).

The definition of $T2$ is the time that it takes for the transverse magnetization to decay to 37% of its original value (Fig 14). Different tissues have different values of $T2$ and dephase at different rates. White matter has a short $T2$ and dephases rapidly. CSF has a long $T2$ and dephases slowly.

Figure 15. T2-weighted contrast. Different tissues have different rates of T2 relaxation. If an image is obtained at a time when the relaxation curves are widely separated, T2-weighted contrast will be maximized. *Mag* = magnetization.

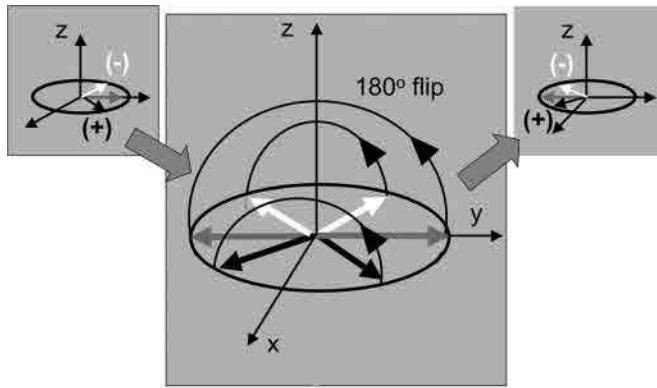
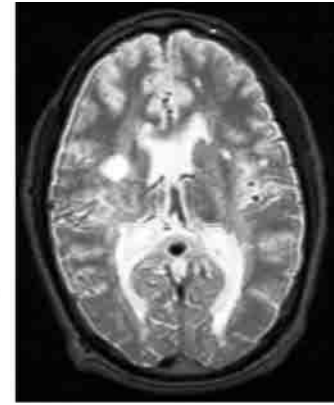
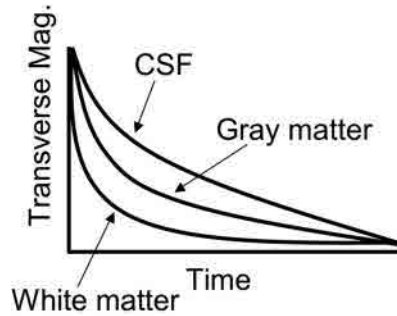

16.

Figures 16, 17. (16) Mechanism of spin echo. After transverse magnetization has begun to dephase in the transverse plane, application of a 180° RF pulse will rotate the proton spins to the opposite axis. This rotation will allow the spins to rephase and form an echo. (17) Formation of spin echoes. Application of a 90° RF pulse results in an immediate signal (called a free induction decay [FID]), which rapidly dephases due to T2* effects. Application of a 180° RF pulse will allow formation of an echo at a time TE . Multiple 180° pulses will form multiple echoes. *Mag* = magnetization.

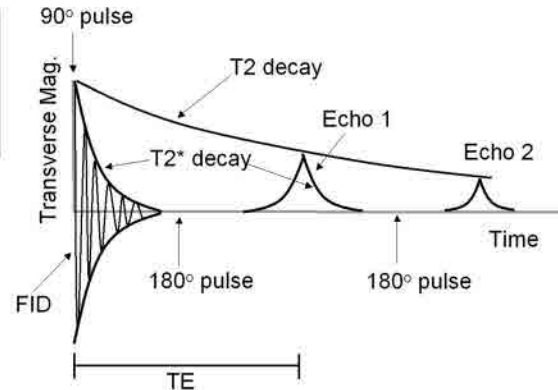

17.

Gray matter has an intermediate T2 and dephases intermediately (Fig 15).

We are able to take advantage of these differences and produce images based on this contrast mechanism, called T2-weighted contrast. If we were to create an image at a time when the transverse magnetization curves were widely separated, then we would have high contrast between the tissues in our image. We would see that CSF is associated with lighter pixels, white matter is associated with darker pixels, and gray matter is associated with intermediate gray-level pixels. If we were to create an image at a time when the curves were not widely separated, the image would not have much T2-weighted contrast.

The T1 and T2 relaxation processes occur simultaneously. After a 90° RF pulse, dephasing of the transverse magnetization (T2 decay) occurs while the longitudinal magnetization grows back

parallel to the main magnetic field. After a few seconds, most of the transverse magnetization is dephased and most of the longitudinal magnetization has grown back.

Spin Echo

The spin echo is the “trick” that can be used to recover dephasing due to all effects except spin-spin interactions. After a 90° RF pulse, protons that were in phase begin to dephase in the transverse plane due to effects discussed earlier (represented by some spins going faster than the average and some spins going slower than the average) (Fig 16). After a certain amount of time, if a 180° RF pulse is applied, the spins will rotate over to the opposite axis. Now, rather than the spins continuing to dephase, the spins will begin to rephase.

The spins will come back together and the signal measured with our receiver coil will increase, form a maximum signal, and then decrease as the spins once again dephase (Fig 17). At this time,

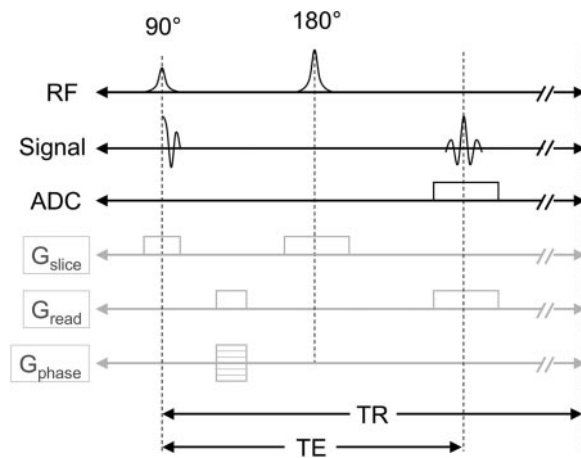

Figure 18. Pulse sequence diagram. A pulse sequence diagram can be used to show the relative timing of certain events during an MR imaging acquisition. The timing of RF pulses, the signal formed from these pulses, and the digitization of the signal is shown. TE is shown as the time to the echo, and the repetition time (*TR*) is shown as the time it takes to go through the pulse sequence once. This pulse sequence uses a 90° RF pulse with a 180° RF pulse to rephase spins to form an echo. T1- and T2-weighted images may be created with this pulse sequence. *ADC* = analog-to-digital converter; in all pulse sequence diagrams, *G* = gradient.

another 180° RF pulse could be applied to rephase the spins again. The rephasing of the spins forms an “echo” called a spin echo. The time between the peak of the 90° RF pulse and the peak of the echo is called the time to echo or echo time (TE). Note that the curve formed by connecting the peaks of the echoes represents decay by T2 effects (spin-spin interactions), whereas the initial faster decay observed immediately after the 90° RF pulse or during echo formation is due to T2* effects (which include all decay processes listed in the Table).

What has not been explained is why decay due to three of the processes can be reversed, but decay due to one process, spin-spin interactions, cannot be reversed. We will continue with the example of magnetic field inhomogeneities to explain this. Although the magnetic field is not perfectly homogeneous, the imperfections remain constant over time and do not move in their position. We take advantage of this with the spin echo and 180° RF pulse.

If a proton experiences a local increase in magnetic field strength that is not experienced by a neighboring proton, it will precess faster than its neighbor. Because this imperfection in the magnetic field is constant, the proton will always spin faster than its neighbor. Prior to the 180° RF pulse, the proton spins faster “away” from its

neighbor. After the 180° RF pulse, the spins are “flipped” and their directions can be thought to be reversed, so that now the faster proton is “behind” its neighbor and can “catch up” to its neighbor because it is still spinning faster. On the other hand, spin-spin interactions are random interactions between protons that cause random local changes in the magnetic fields experienced by the protons, and this causes dephasing. Because this is a random process, dephasing due to this effect cannot be reversed.

Referring to Figures 14 and 15 for T2 decay, similar figures could be drawn showing T2* decay. As discussed later, an echo can be produced without application of a 180° RF pulse by using gradients alone. In this case, the rate of rephasing and dephasing of the echo would be due to all effects listed in the Table. If we were to create an image at a time when the transverse magnetization curves were widely separated, then we would have high T2*-weighted contrast between the tissues in our image.

Pulse Sequence Diagrams

We have discussed fundamental concepts and have used those to describe T1 and T2 relaxation and contrast. For MR imaging, we need to learn how to create and control this contrast. This can be done by describing the MR pulse sequence, which shows the timing of certain events during MR acquisition.

The events that will be discussed include RF pulses and the signal that is formed from these pulses. Other events that are included in pulse sequence diagrams are the timing of gradient pulses. Gradient pulses will be described in detail in a future article in this series. They are responsible for localizing the “signals” from protons (which are located in the body at different positions) in our images in three dimensions, through the formation of image sections and pixels in those sections. The timing of the gradient pulses will be included in the figures of pulse sequences (in gray).

The horizontal lines in the pulse sequence diagram of Figure 18 indicate the relative timing of events. Lines are shown for the timing of RF pulses, the signal formed from these pulses, and when the signal is digitized for storage in the acquisition computer by the analog-to-digital converter (ADC).

TE and TR

Initially, it is of primary importance to use the pulse sequence diagram (Fig 18) to describe the MR image acquisition parameters TE and TR. TE has already been described as the time between the peak of the 90° RF pulse and the peak of the echo that is formed. Note that the 180° RF pulse occurs at half of the echo time TE. A parameter not yet discussed is the repetition time or TR. TR is the time that it takes to run through the pulse sequence one time.

A subsequent article will discuss how the raw image data are collected and reconstructed to form an image. For now, we will assume that the raw data have the same number of rows and columns as the reconstructed image. For basic pulse sequences, one time through the pulse sequence provides one row of raw data. We must repeat the pulse sequence as many times as necessary to provide as many rows of data as are needed to reconstruct the image. If we wish to acquire an MR image with a matrix of 256 pixels by 256 pixels, that is 256 rows of data and 256 columns of data. Because one time through the pulse sequence provides one row of data (in 256 columns), we must repeat the pulse sequence 256 times to acquire all the rows needed. TR is the time it takes to go through the pulse sequence one time. In order to acquire all rows of data, it will take a time equal to TR times 256.

Contrast Formation

Recall that the goal of MR imaging is to create images that have certain contrasts. From Figures 11 and 15, we see how the longitudinal and transverse magnetizations relax due to T1 and T2 effects. TE and TR can be used to control the amount of “weighting” of these effects in our image. Figures 19–21 show the relative values of TE and TR to produce these different image contrast weightings. When effects from T2 relaxation are minimized (curves not widely separated) and effects from T1 relaxation are maximized (curves widely separated), we would produce a T1-weighted image (Fig 19). If T1 effects are minimized and T2 effects are maximized, we would produce a T2-weighted image (Fig 20). If both T1 and T2 effects are minimized, we will produce an image with “proton density” or “spin density” weighting (Fig 21).

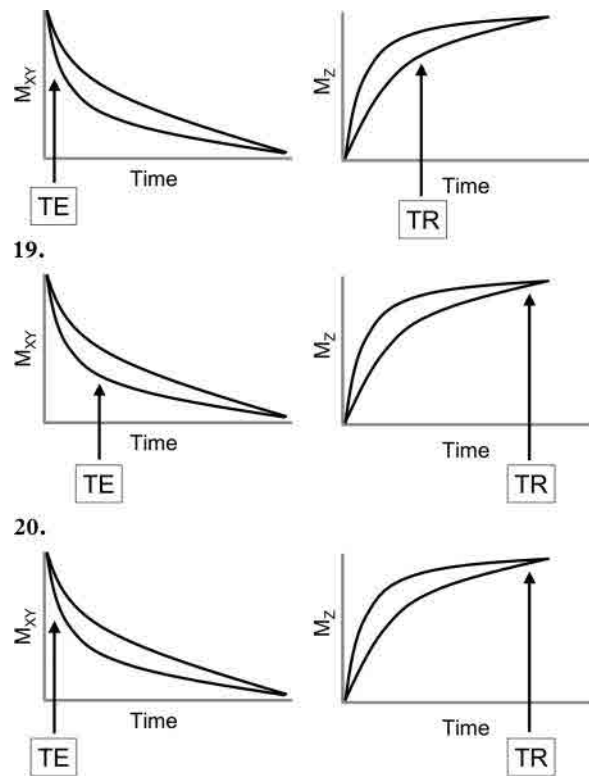

21.

Figures 19–21. (19) Parameters for T1 weighting. Short TE (producing minimal T2 weighting) and intermediate TR (producing maximal T1 weighting) will result in a T1-weighted image. (20) Parameters for T2 weighting. Long TE (producing maximal T2 weighting) and long TR (producing minimal T1 weighting) will result in a T2-weighted image. (21) Parameters for proton density weighting. Short TE (producing minimal T2 weighting) and long TR (producing minimal T1 weighting) will result in a proton density-weighted image.

Basic Pulse Sequences

Several basic pulse sequences will now be discussed. The first pulse sequence will be the spin-echo sequence. Other pulse sequences will be compared to the spin-echo sequence; the figures will highlight the differences between that pulse sequence and the spin-echo sequence.

Spin Echo

The spin-echo pulse sequence (Fig 18) can produce proton density weighting, T1 weighting, and T2 weighting. TE and TR are set as discussed earlier to achieve these weightings. Typical values of TE and TR for T1 weighting (at 1.5 T) are TE = 20 msec and TR = 500 msec; the typical

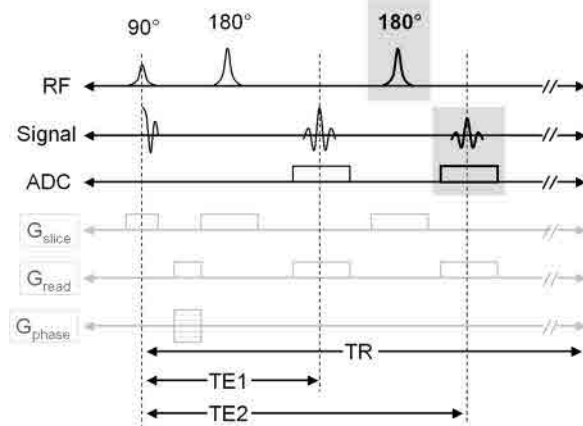

Figure 22. Multiecho spin-echo pulse sequence. This sequence uses a 90° RF pulse with multiple 180° RF pulses to form multiple echoes. Each echo can be used to create a separate image data set with different contrast weighting. The gray highlighting shows the differences between this pulse sequence and the basic spin-echo sequence.

values for T2 weighting are TE = 80 msec and TR = 2,000 msec. Comparing this figure to Figure 17, we see that the 90° RF pulse produces an initial signal (free induction decay), which is not used. The 180° RF pulse occurs at half the TE time, and the echo is centered at TE. The ADC (analog-to-digital converter) line indicates that the echo is digitized and stored in the computer as raw data.

Multiecho Spin Echo

The multiecho spin-echo pulse sequence uses multiple 180° RF pulses to generate multiple echoes (Fig 22). Each echo occurs at a different TE and is used to form a separate image data set, which will have different contrast weighting ranging from proton density to T2. The differences between this pulse sequence and the basic spin-echo pulse sequence are highlighted in Figure 22. Typical TR may be 2,000 msec, with TE1 = 20 msec and TE2 = 80 msec, resulting in proton density- and T2-weighted image data sets, respectively.

Turbo Spin Echo

The turbo spin-echo (or fast spin-echo) pulse sequence is shown in Figure 23. Note the differences here compared to the basic spin-echo pulse sequence. Again, multiple 180° pulses are used to create multiple echoes. However, instead of each

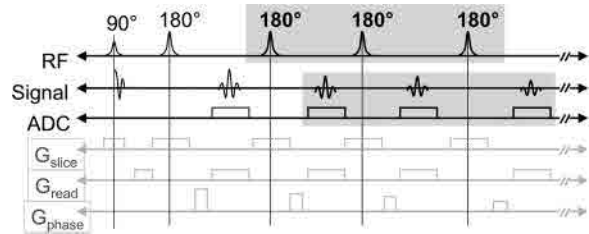

Figure 23. Turbo spin-echo pulse sequence. This sequence uses a 90° RF pulse with multiple 180° RF pulses. Multiple echoes are formed, and the data are used to create a single data set. Multiple rows of raw data are filled during one TR period; this feature allows the pulse sequence to be run fewer times, thus saving imaging time.

echo forming a different image data set, all the echoes are used to create a single image data set at a faster rate. A new acquisition parameter will be introduced called the echo train length, which is the number of echoes that are formed.

Recall that the echo is digitized and the data from this echo are used for one row of raw data. Recall also that the pulse sequence must be repeated as many times as is needed to acquire all the rows of raw data. In the turbo spin-echo sequence, if four echoes are produced (each time through the pulse sequence), the digitized data from these four echoes can be used for four different rows of raw data. If 256 rows of raw data are needed, and four rows of raw data are acquired each time through the pulse sequence, then the sequence must be repeated only 64 times rather than 256 times. With TR the same as in a spin-echo sequence, this would result in a factor of four speed increase in data acquisition. Likewise, an echo train length of eight or 16 will decrease imaging time by a factor of eight or 16, respectively.

The turbo spin-echo pulse sequence can be used to produce T1 and T2 contrast weighting. Each echo will still occur at a different TE and thus will really have a different contrast weighting associated with it. However, there is a way that we can use the echoes closest to our TE of interest to form the contrast weighting that we desire. This will become more clear when we understand how the raw data are acquired and used to form an image (explained in a later article).

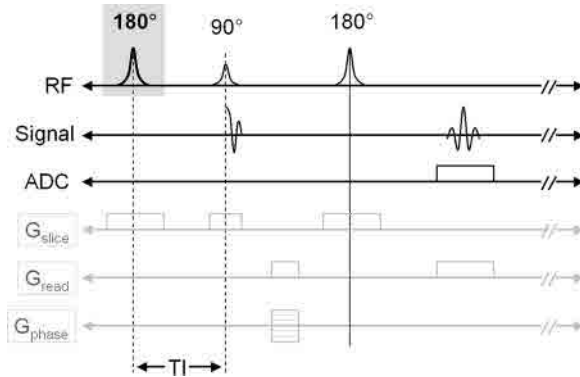

Figure 24. Inversion-recovery pulse sequence. This sequence is similar to the basic spin-echo sequence with the addition of an initial 180° inversion pulse. This sequence can be used to suppress the appearance of unwanted signals (eg, those due to fat or fluid). TI = inversion time.

Inversion Recovery

The inversion-recovery pulse sequence (Fig 24) is useful for suppressing unwanted signals in MR images (eg, signals from fat or fluid). Contrast weighting can still be controlled through selection of TR and TE, as described earlier.

The difference between this and the spin-echo pulse sequence is the occurrence of the 180° RF pulse prior to the regular spin-echo pulse sequence. The 180° RF pulse causes an initial inversion of the longitudinal magnetization (so that it is aligned in the $-z$ direction), as shown in Figure 25. The magnetization then begins to grow back in the direction of the main magnetic field ($+z$). The magnetization of different tissues will grow back at different rates. When the signal from the tissue to be suppressed crosses the zero axis, application of a 90° RF pulse will rotate all other signals into the transverse plane. Since the signal from the tissue at the zero point is zero, there is nothing to rotate into the transverse plane. Thus, this tissue will not contribute any brightness to the resulting image.

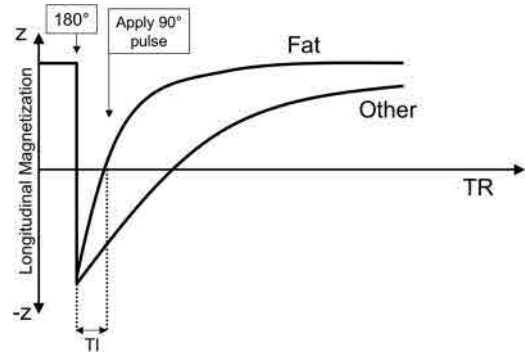

Figure 25. Inversion of the signal in the inversion-recovery sequence. After initial inversion of the longitudinal magnetization, T_1 relaxation occurs and the signals from different tissues cross the zero axis at different times. When the signal to be suppressed crosses the zero axis, a 90° RF pulse will rotate all other signals into the transverse plane for image formation. TI = inversion time.

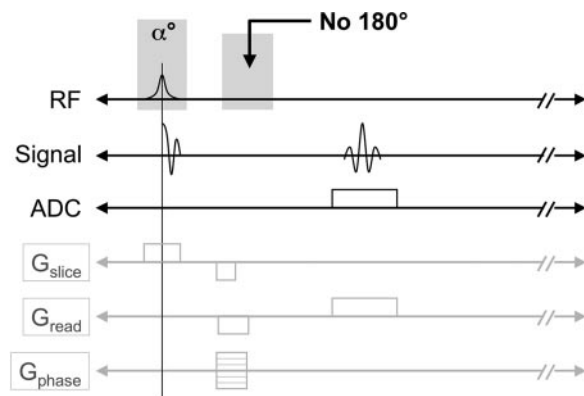

Figure 26. Gradient-recalled-echo pulse sequence. This sequence is similar to the spin-echo sequence except that the initial RF pulse is less than 90° and there is no 180° RF pulse. Signal dephasing and rephasing by means of gradient pulses results in formation of a gradient echo, which is used to produce T_1 - or T_2^* -weighted images.

The acquisition parameter TI (time of inversion) is the time between the initial 180° RF pulse and the 90° RF pulse. Fat relaxes relatively quickly, and a short TI of approximately 170

msec is used to suppress signal from fat at a field strength of 1.5 T. This method can also be used to suppress signal from other tissues that cross through the zero point by appropriate application of TI for that tissue.

Gradient Recalled Echo

Finally, the pulse sequence diagram for the gradient-recalled-echo sequence is shown in Figure 26. Initial inspection shows the difference between this sequence and the basic spin-echo sequence to be an initial RF pulse flip angle of something less than 90° (eg, 20° or 30°) and the lack of a 180° RF pulse. The smaller flip angle and lack of 180° RF pulse allow the TR to be much shorter, resulting in very fast imaging times. Even though there is no 180° RF pulse to produce a spin echo, gradient pulses (which we have not discussed) can be used to dephase and rephase the signal in the transverse plane to form gradient echoes. In this case, T2-weighted image contrast cannot be produced; rather, T1 and T2* image contrast can be produced.

Conclusions

Many concepts fundamental to an understanding of MR imaging have been presented. It will be important for those new to this imaging modality to review these concepts and be able to apply these to more complicated situations in MR imaging. Some basic core elements of MR imaging were initially discussed, and these formed a foundation for subsequent discussion of T1 and T2

contrast mechanisms and several different pulse sequence acquisition strategies. Other topics that remain to be presented in future articles in this series include localization of the MR signal by using gradients, instrumentation, image artifacts, and safety.

Suggested Readings

- Bushberg JT, Seibert JA, Leidholdt EM Jr, Boone JM. Nuclear magnetic resonance. In: *The essential physics of medical imaging*. 2nd ed. Philadelphia, Pa: Lippincott Williams & Wilkins, 2002; 373–413.
- Elster A, Burdette J. *Questions and answers in magnetic resonance imaging*. 2nd ed. St Louis, Mo: Mosby, 2001.
- Hendee WR, Ritenour ER. *Fundamentals of magnetic resonance*. In: *Medical imaging physics*. 4th ed. New York, NY: Wiley-Liss, 2002; 355–365.
- Mitchell DG. *MRI principles*. Philadelphia, Pa: Saunders, 1999.
- Pooley RA, Felmlee JP, Morin RL. Basic principles and terminology of magnetic resonance imaging. In: Berquist TH, ed. *MRI of the musculoskeletal system*. 4th ed. Philadelphia, Pa: Lippincott Williams & Wilkins, 2001; 1–29.
- Runge VM, Nitz WR, Schmeets SH, et al. *The physics of clinical MR taught through images*. New York, NY: Thieme, 2005.
- Wolbarst AB. Magnetic resonance imaging I: nuclear magnetic resonance of stable hydrogen nuclei in the water molecules of tissues. In: Wolbarst AB, ed. *Physics of radiology*. 2nd ed. Madison, Wis: Medical Physics, 2005; 128–138.